

ELECRAFT AF1 Active Audio Filter

Assembly and Operating Manual

E740102: Revision A, September 7, 2006
Copyright © 2006, Elecraft; All Rights Reserved

Introduction

The Elecraft AF1 is a versatile audio filter that can be used with any receiver or transceiver. It can improve intelligibility of CW, phone, or data signals, and is especially well suited to radios that have inadequate I.F. or audio filtering. The AF1 uses straightforward analog circuitry and no surface-mount components, so it's an ideal project for first-time kit builders.

A rotary switch on the unit allows you to select a low-pass characteristic with adjustable upper frequency roll-off, or a narrow bandpass characteristic. The bandpass filter offers two levels of selectivity, and its center frequency may be tuned from about 350 Hz to about 950 Hz. The low-pass filter is active during bandpass operation, allowing you to further control the upper frequency response. The output amplifier drives low impedance phones or a small loudspeaker. Power can be supplied via either an on-board 9-V battery or an external supply. An LED indicates power on/off status.

Specifications

Size: 5-1/2" L x 2-7/8" W x 7/8" H (14 cm x 7.3 cm x 2.2 cm). Height not including feet or knobs.
Internal Power: 9V battery.
External Power: 7-14 V (8 V min. recommended).
Current Drain: 10 mA minimum volume to 100 mA full volume, typical.
Functions: Low pass plus two levels of bandpass with tunable center frequency in bandpass mode.
See *Typical Response Plots* on page 8.

Tools Required

You will need the following tools to build this kit:

- Fine-tip temperature-controlled ESD-safe soldering station with 700 to 800°F tip (370-430°C). Recommend a spade tip no greater than 0.05" (1.3 mm) wide.
- IC-grade solder (Kester #44 or equivalent). Small diameter solder (e.g. .031") is easiest to work with on small printed circuit boards. **DO NOT use acid-core solder, water-soluble flux solder, additional flux or solvents.**
- Small, #2 Phillips screwdriver.
- Needle-nose pliers.
- Diagonal cutters.
- Small wrench or driver for 4-40 nut.
- Digital Multimeter (DMM) with voltage, resistance and diode-checking functions is useful for confirming the value of components. A DMM with capacitance measurement capability is desirable, but not required.
- Desoldering tools and supplies are invaluable. Narrow solder wick or a good vacuum desoldering tool such as the Soldapull® model DS017LS are recommended.

Refer to www.elecraft.com for tool sources and solder recommendations.

Parts List

We strongly recommend that you do a complete inventory before beginning assembly. The inventory helps you correctly identify all the parts to avoid mistakes during assembly.

Identifying Parts

In some cases the component marking is self-evident. A 1N4007 diode, for example, will have "1N4007" stamped on its body. When the markings are not so obvious, the marks you should find to identify individual components are shown in parenthesis in the parts list and text. These may be numbers such as "(103)" on capacitors or colors on resistors such as

“(brn-blk-red)”. Look for the color band sequence starting near one end of the component. Some resistors have dark blue bodies that make identifying the colors difficult. Use your DMM to verify the value if you aren’t sure. Remember that your DMM usually will indicate a value close to, but not exactly what is shown, due to normal tolerances in the components and the DMM.

There may be more numbers, letters or color bands on a component than those shown in parenthesis. The additional markings may change from unit to unit and are not important for identifying the part supplied with the kit.

Reference. Designator	Description	Qty	Part Number
Misc.	AF1 Audio Filter Printed Circuit Board	1	E100310
B1	Battery Holder	1	E980074
C1, C10	1 μ F 50V Electrolytic Capacitor	2	E530022
C2, C3, C11	470 μ F 25V Electrolytic Capacitor	3	E530084
C4, C7, C8 , C9, C13	.01 μ F (103) Capacitor	5	E530009
C5	.0022 μ F (222) Capacitor	1	E530054
C6	.1 μ F (104) Capacitor	1	E530011
C12	.047 μ F (473) Capacitor	1	E530025
R1	1.5k (brn-grn-red) 1/4W Resistor	1	E500034
R2, R4, R7, R14	1.0k (brn-blk-red) 1/4W Resistor	4	E500013
R3	15k (brn-grn-org) 1/4W Resistor	1	E500060
R6	10k (brn-blk-org) 1/4W Resistor	1	E500015
R8, R11	180k (brn-gry-yel) 1/4W Resistor	2	E500068
R9, R12	680 Ω ((blu-gry-brn) 1/4W Resistor	2	E500040
R17, R13	360 Ω (org-blu-blk-org) 1/4W Resistor	2	E500264
R16	10 Ω (brn-blk-blk) 1/4W Resistor	1	E500054
R18	22k (red-red-org) 1/4W Resistor	1	E500090
R10	5k (502) dual potentiometer, linear taper	1	E520019
R15	10K (10KD) potentiometer	1	E520018
R5	50K (50KB) potentiometer	1	E520017
D1, D2	1N4007 Diode	2	E560001
D3	LED, Red, Ultra bright	1	E570025
J1, J3	Jack, Stereo, 3.5 mm	2	E620027
J2	Jack, 2.1 mm, 12VDC power	1	E620026
SW1	Switch, Rotary, 3 Pole, 4 Position, Non-Shorting, PC	1	E640033
U1	LM348 Integrated Circuit	1	E850231
U2	LM386 Integrated Circuit	1	E600022
Hardware	Screw, Pan Head, Black Machine, 4-40	4	E700008
Hardware	Lock Washer, Internal Tooth, #4	4	E700010
Hardware	Nut, #4-40	4	E700011
Misc	Knob w/set screw for 1/4 inch shaft	4	E700118
Misc	Rubber Foot	4	E700024

Assembly Options

The AF1 is designed to operate as a stand-alone unit without an enclosure. In the event you want to build it into existing equipment or its own enclosure:

1. Four holes are provided in the board that you may use with your own #4 hardware and spacers as needed to mount the unit instead of using the rubber feet.
2. The battery may be mounted on the top (component side) or bottom of the board or you may choose not to install the battery holder if you are going to power your AF1 only from an external source.

Assembly Procedure

The finished audio filter is shown in Figure 1. The knobs were left off to better show the components on the board. We recommend you follow the assembly procedure below, and refer to this figure as needed.

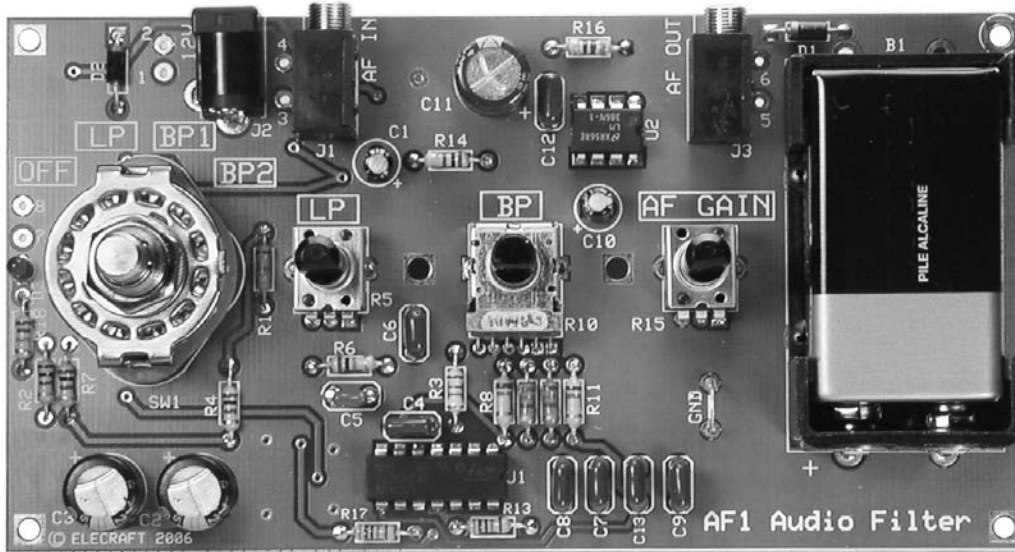

Figure 1. Assembled Audio Filter.



Use adequate ventilation when soldering; avoid inhaling smoke or fumes. Always wash your hands after handling solder, as lead residue is highly toxic.

When applying solder, use the *minimum* amount required to surround the component lead and make good contact with its printed-circuit pad. You don't need a "fillet" (build-up) of solder. This will avoid unwanted solder bridges and any need to clean the PC boards.

The solder must flow onto both the component lead and its PC board pad. To ensure that both will be heated at the same time, the tip of the iron should contact both the component lead and the PC board pad before solder is applied.

Solder joints should be *clean* and *shiny*. If a joint appears dull or has fine cracks, it is probably cold. Cold solder joints should be cleaned and re-soldered. First, use solder wick (desoldering braid) to remove the old solder. Then apply fresh solder. If you have many cold solder joints, it probably indicates that your soldering iron temperature is too low, or that the tip or solder itself is defective.

Install the fixed resistors listed below. Position each resistor within the outline on the PC board, solder and trim the leads flush on the bottom. If you position the board so the legends are right side up, you can work from left to right across the board following the order given below. Save one of the clipped leads. You will use it to make a ground test point later.

__ R18, 22k (red-red-org)	⇒	__ R2, 1K (brn-blk-red)
__ R7, 1K (brn-blk-red)	⇒	__ R4, 1K (brn-blk-red)
__ R1, 1.5k (brn-grn-red)	⇒	__ R6, 10k (brn-blk-org)
__ R17, 360k (org-blu-blk-org)	⇒	__ R14, 1.0k (brn-blk-red)
__ R3, 15k (brn-grn-org)	⇒	__ R13, 360k (org-blu-blk-org)
__ R8, 180k (brn-gry-yel)	⇒	__ R9, 680Ω ((blu-gry-brn)
__ R12, 680Ω ((blu-gry-brn)	⇒	__ R11, 180k (brn-gry-yel)
__ R16, 10Ω (brn-blk-blk)		

Install the capacitors listed below just as you did with the resistors in the previous step:

__ C5, .0022 μ F (222) \Rightarrow __ C4, .01 μ F (103)
__ C6, .1 μ F (104) \Rightarrow __ C12, .047 μ F (473) See note.
__ C8, .01 μ F (103) \Rightarrow __ C7, .01 μ F (103)
__ C13, .01 μ F (103) \Rightarrow __ C9, .01 μ F (103)

Note: The + symbol next to outline for C12 refers to electrolytic capacitor C11 that you'll install later. C12 may be installed oriented either way, just like the other capacitors in this group.

Locate LED D3. Note that one lead is slightly longer than the other. **Insert the long lead in the lower, round solder pad** in the space for D3 on the left edge of the board. Position the LED as close to the board as it will fit. Solder and trim the leads flush with the bottom of the board.

Locate diodes D1 and D2 (1N4007). Note the silver band at one end of the diode body. **Install the diodes with the silver stripe aligned with the stripe on the silk screened outline on the board.**

__ D2, 1N4007 (near upper left corner) \Rightarrow __ D1, 1N4007 (near upper right corner)

Inspect the leads of one of the electrolytic capacitors. Note that there is a stripe with a – on the body to identify the negative lead. **The negative lead must be inserted in the round solder pad on the board.** The positive lead must be inserted in the square solder pad. There is a + symbol near that pad. The positive lead is slightly longer on most capacitors. Install the electrolytic capacitors as follows:

__ C2, 470 μ F \Rightarrow __ C3, 470 μ F \Rightarrow __ C1, 1 μ F
__ C11, 470 μ F \Rightarrow __ C10, 1 μ F

Bend the clipped resistor lead you saved earlier into a “U” that fits into the solder pads at each end of the GND test point near C9. Solder the lead into the pads with the loop high enough above the board to easily clip a test probe lead onto it.

Install U1 (LM348) as follows:

- Place U1 on the board where shown by the outline near the bottom center. If the pins are spread too wide to fit, place U1 on its side on a solid, flat surface and rock it gently to bend all the pins inward slightly as shown in Figure 2. Do the same on both sides until it fits into the solder pads on the board.
- Align the end of U1 that has a notch or dimple molded in the case with the notch on the silk screened outline.
- Hold U1 in place, wet the tip of your soldering iron with solder and touch one of the corner pins on the bottom of the board to tack-solder it in place.
- Make sure U1 is correctly positioned and flat against the board, then solder the remaining pins.
- Reheat the tack-soldered pin as needed to ensure it is properly soldered.

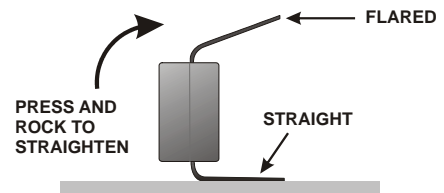

Figure 2. Straightening I.C. Pins.

Install U2 (LM386) using the same procedure you used for U1.

Install the 12VDC power connector, J2, as follows:

- Position the connector over the J2 outline on the board.
- Tack-solder one pin to hold it in place.
- Check the position of the connector. If necessary reheat the soldered pin to adjust it.
- Solder the remaining two terminals, then finish soldering the terminal you tacked in place.

Install the stereo jacks using the same procedure you used for the 12VDC connector above:

__ J1 ⇒ __ J2

Install dual potentiometer R10 (502) as follows:

- Position R10 on the board. Be sure all six pins pass through their respective solder pads, then press down on the body of the potentiometer, if necessary, to snap it in place. Do not push on the shaft.
- Solder only one pin, then inspect the potentiometer to be sure it is sitting flat against the board. Look at it from two directions to be sure the shaft is perpendicular to the board. If necessary, reheat the soldered pin and reposition the R10.
- Solder all six signal pins and the two side clips to the board.

Install potentiometers R5 and R15 using the same procedure you used for R10:

__ R5 (50KB) ⇒ __ R15 (10KD)

Install rotary switch SW1 as follows:

- Position SW1 inside its outline on the board. Note that the pins will fit through the solder pads when the switch is oriented one way.
- Solder one pin and inspect the switch to be sure it is perpendicular to the board, just as you did for the potentiometers.
- Solder all the pins.



The battery holder may be installed on the top or the bottom of the board. Normally you will want to install it on the top so the finished unit will sit flat on its feet. However, if you plan to install the filter in an enclosure, you can mount the battery holder on the bottom of the board. Solder pads are provided to mount the holder on either side as indicated on the circuit board. Also, if plan to supply only external power to the filter, you can leave the battery holder off entirely.

Install the battery holder as follows:

- Position the battery holder on the board within the outline. Be sure you have it on the correct side of the board. Unless you have a special need, you will want to put it on the top side along with the other components. Do not solder yet.
- Attach the holder to the board with the 4-40 screws in four places, using lock washers and nuts. The screw heads should be on the holder side so the battery will fit correctly. You may need to bend the battery holder terminals slightly to align the screw holes with those in the board.
- Solder the two terminals to the pads and trim them flush.

Attach the four feet to the corners of the board on the bottom. If you plan to build the filter into a rig or separate enclosure, you may leave the feet off and use the four corner holes for mounting the filter.

Attach the four knobs to the rotary switch and potentiometer shafts. Line up the index mark on the knob for the rotary switch so it is pointing to OFF when the switch is rotated to the fully left position. The potentiometer shafts may wobble a little because long shafts are required to approximate the height of the rotary switch shaft.

Checkout and Operation

If you have difficulty with the following steps, refer to the circuit description and troubleshooting notes in the following sections.

Install a 9-volt battery in the holder or connect a d-c supply between 9 and 14VDC to J2 (positive to center pin).

Connect an audio source to the AF IN jack (J1). This can be a headphone output from your receiver or other audio source.

- Connect your headphones or a small loudspeaker to the AF OUT jack (J3).
- Position the LPF, BP and AF GAIN pots to minimum (counter-clockwise).
- Turn SW1 to LP (low-pass) position. The red LED D3 should light.
- Rotate the AF GAIN clockwise for a convenient audio level in the phones or loudspeaker.
- Rotate the LP pot clockwise. You'll hear high frequency sound increase in volume as you turn the pot. This is raising the cutoff frequency from minimum (fully counter-clockwise) to maximum. Leave LP fully clockwise.
- Rotate SW1 to BP1 (bandpass filter 1) position. If possible supply a single frequency tone to the input (such as tuning in a CW signal on your rig).
- Rotate the BP pot. The volume of the signal will rise abruptly as you pass its frequency.
- Rotate SW1 to BP2 (bandpass filter 2) position and repeat tuning the BP pot. You should notice that the adjustment is now noticeably sharper. BP 2 adds a second bandpass filter to further improve the selectivity.



Be sure the LPF is always set so it will pass the frequency you've chosen for the bandpass filter. You can set the LPF cutoff frequency close to the BPF frequency so it aids in rejecting high-frequencies above the bandpass frequency.

Circuit Description

Refer to the schematic diagram on page 7. The filter circuit uses a quad operational amplifier integrated circuit that features excellent isolation between the stages. Audio applied at J1 passes through a low-pass filter formed U1A and B. Potentiometer R5 varies the high-frequency cutoff. U1C and D form two independent bandpass filters whose center frequencies are controlled by ganged potentiometers R10A and R10B. These stages tune together so they are both centered on the same frequency at all times. U2 is an audio amplifier that drives the AF output.

Rotary Switch SW1 has three sections. Section B selects the output of the low-pass filter, the output of the low-pass filter plus one bandpass filter, or the output of the low-pass filter plus both bandpass filters. In the OFF position, SW1C routes the audio from the input directly to the output so you don't have to remove the filter when it is not in use. SW1A controls power to the filter.

The power circuit allows you to use either a 9V battery or an external power supply. Diodes D1 and D2 isolate the battery from an external supply to avoid the possibility of an external supply driving current into the battery and causing it to rupture.

Troubleshooting

If LED D3 does not light when SW1 is positioned to LP, check the orientation of diode D1 (if using internal battery) or D2 if using an external supply. Test points 2 (+) and 1 (-) also allow you to check to be sure voltage is present at J2. Next check the voltage across test points 7(+) and 8(-). If the voltage is above about 2VDC, D3 is either installed backwards or it is defective.

If there is power but no audio output except when SW1 is in OFF position, turn the AF GAIN pot fully clockwise and touch a metal test probe to the center pin of pot R15. You should hear a slight click, indicating that amplifier U2 is working. If so, the problem is most likely in the circuits of U1A or U1B. Similarly, loss of output or function in BP1 indicates a problem in the U1C circuit and problems in BP2 indicates a problem with the U1D circuit (see the schematic diagram on the next page). The usual cause of problems in these stages is an incorrectly installed part, an electrolytic capacitor installed backwards or a solder bridge across two adjacent pads. Use a magnifier and carefully inspect the board for correct component values and solder bridges around the affected circuit.

Schematic Diagram

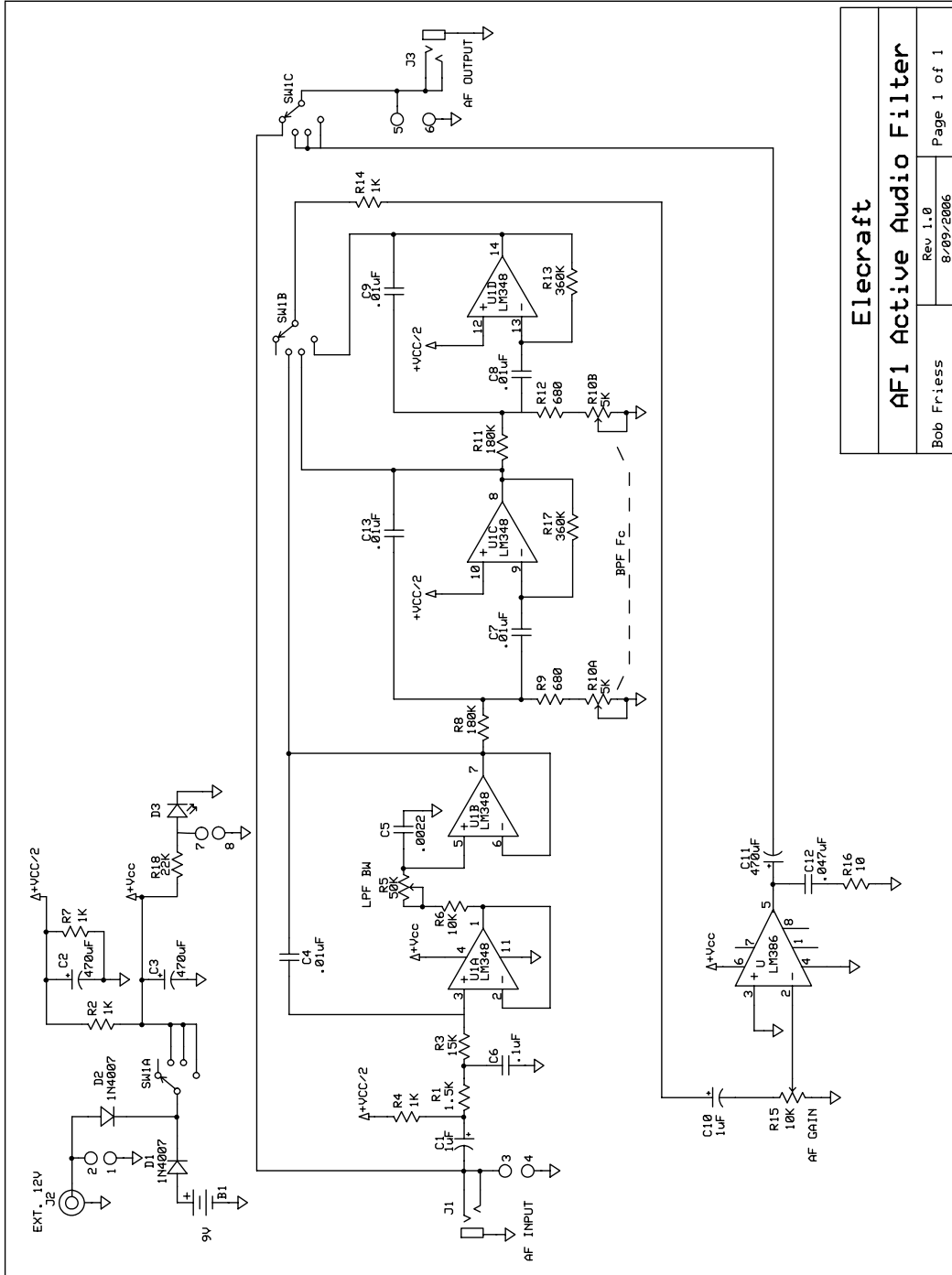

Elecraft	
AF1 Active Audio Filter	
Bob Friess	Rev 1.0
	8/09/2006
	Page 1 of 1

Typical Response Plots

The following plots AF1 plots were made with a network analyzer. The results should be typical of your filter.

LOW PASS FILTER AT MAXIMUM BANDWIDTH

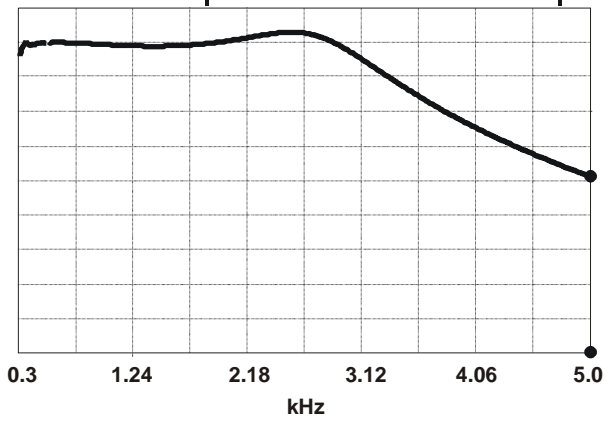

LOW PASS FILTER AT MINIMUM BANDWIDTH

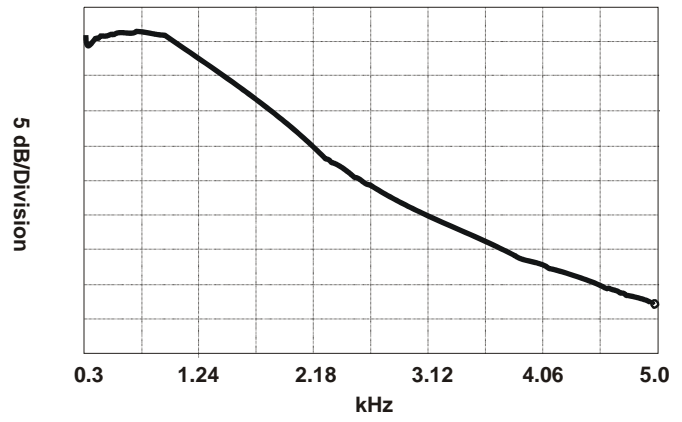

BANDPASS FILTER POSITION 1
LOW PASS FILTER SET TO MAXIMUM BANDWIDTH

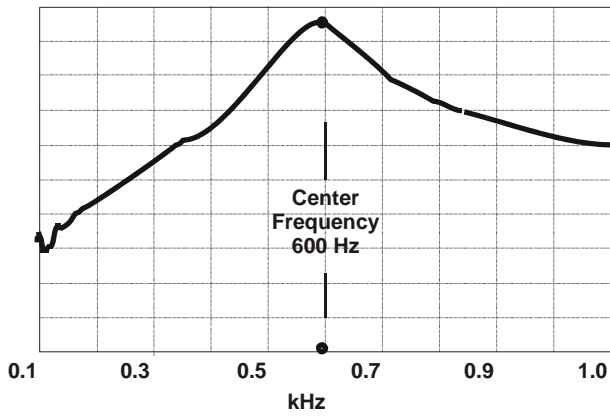

BANDPASS FILTER POSITION 2
LOW PASS FILTER SET TO MAXIMUM BANDWIDTH

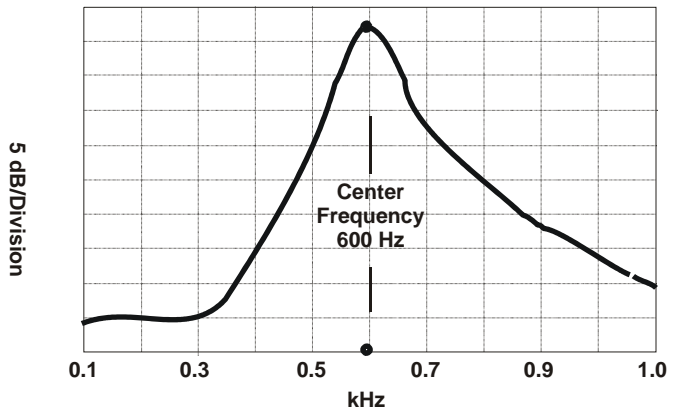

BANDPASS FILTER POSITION 2
LOW PASS FILTER SET TO MINIMUM BANDWIDTH

